

FAST TRANSIENT BURST SIMULATOR



FNS-AX3

GENERAL

Electrical fast transients (EFT), such as switching transients originating from inductive load interruption, relay contact bounce, etc., are one of the main causes of equipment malfunctions, because they can occur anywhere, interfering with circuits primarily via mains and interconnection cables.

EFT is characterized by fast rise times and a short duration of pulses. Also significant is the fact that EFT comes in bursts with repetition rates exceeding 100kHz. In the real world, an EFT event is a series of pulses with changing amplitudes and repetition rates. For test purposes, the IEC 61000-4-4 standard defines an idealized EFT/B .

For anyone who wants to build quality products with an extensive test program from design, qualification, production to diagnostic purpose, the FNS-AX3 simulators will serve as a critical tool with a new level of performance and efficiency meeting and far exceeding the IEC standard requirements.



FEATURES

- A new level of ease of use with a touch-panel color LCD and screen design for intuitive settings, color graphical representation and good visibility.
- Three operation modes
IEC61000-4-4 STANDARD mode for an instant use. MANUAL mode for free setting including ramping. SEQUENCE mode for a seamless run of combined settings in Manual mode.
- 4.8kV output at 2MHz pulse repetition rate
Assures the worst case testing
- Valuable additional output modes
Polarity Reversal and Pulse Repetition Frequency Modulation modes are available.
- A wide variety of options
- A single package solution offering a generator and CDN
- Selection of single phase CDN rated 16A or three-phase CDN rated 50A
- Compliance to IEC/EN61000-4-4 Edition 2.0

Additional output modes for the reproduction of troublesome field failures

◆ Polarity reversal

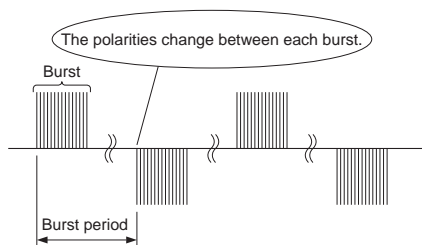

◆ Continuous mode/Pulse repetition frequency modulation

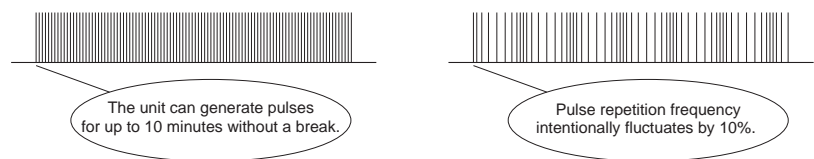

FNS-AX3 series

TOUCH-PANEL COLOR LCD

Easy intuitive test setting. Each operation mode has one or two-layer screen. In conjunction with a unique frame design, a touch-panel color LCD supports a new level of ease of use.

Manual Mode



Self-explanatory graphical representation.

Parameter settings



Touch parameters that require numerical inputs, a ten-key screen will appear.

Standard Mode



The test specifications called for in the IEC61000- 4-4 are preset.

Automatic ramping



Output voltage, pulse repetition frequency, placement phase angle, polarity and coupling line are the parameters, which can be automatically ramped or changed.

SPECIFICATIONS

Parameters	FNS-AX3-A16	FNS-AX3-B50
Output voltage	200-4800V	
Pulse parameters at 50 ohm	Pulse rise time 5ns ±30%, pulse width 50ns ±30% ※	
Pulse parameters at 1k ohm	Pulse rise time 5ns ±30%, pulse width 35 ns to 150 ns ※	
Polarity	Positive, negative, polarity change burst by burst	
Pulse frequency	0.1kHz-2MHz ※	
Burst duration	1~1,000 pulses or Continuous ≤1 pulse per 1ms burst period	
Burst period	10~1000 ms 10ms step	
Continuous mode operation	10 kHz max (0.2~1kV)	
Dynamic output impedance	50 ohms	
Output connector	Coaxial (PULSE OUT)	
Coupling/DC blocking capacitor	33nF/10nF	
Frequency modulation	0 ~ -10% of setting	
Timer (test duration)	1s to 9h 59m 59s, 10 minutes max in the "continuous" and alternate polarity modes	
External trigger	TTL down edge, minimum trigger interval acceptable: 10ms	
Burst timing	Non-synchronization	Irrelevant to EUT mains frequency
	Synchronization	Synchronizes with the EUT mains frequency 0 to 360 degrees ±10 degrees, 1 degree step Burst period: 50/60Hz
Internal CDN	85 ~ 240V AC 16A 50/60Hz 3-wire single-phase 125V DC/ 16A	85 ~ 500V AC 50A 50/60Hz, 5-wire three-phase 125V DC/ 50A
Coupling line	L, N, PE	L1, L2, L3, N, PE
Coupling mode	Common mode	
Dimensions	(W)320x(D)352x(H)400 mm	
Weight	Approx. 14 kg	Approx. 19 kg

※Pulse specifications guaranteed over 5KHz to 100KHz.

IEC 61000-4-4 STANDARD / BASIC EMC PUBLICATIONS

EMC/ testing and measurement techniques / Electrical fast transient/burst immunity test

The standard transient of the IEC 61000-4-4 consists of 50ns wide pulses whose amplitudes vary according to the severity of the test. The transients are coupled to mains and other ports in 0.75/15 ms bursts repeated every 300 ms. Within the burst, the pulse repetition rate is 100kHz or 5kHz. The pulse-train timing is shown in the figure.

- Simplified circuit diagram of a test transient/burst generator
- Waveform of a pulse at a 50Ω load
- Waveform of a pulse at a 1KΩ load

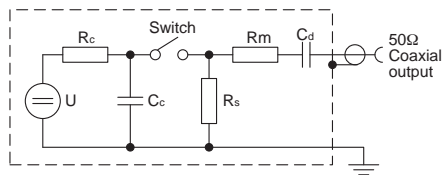

U High-voltage source
 Rc Charging resistor
 Cc Energy storage capacitor
 Rs Impulse duration shaping resistor
 Rm Impedance matching resistor
 Cd D.C. blocking capacitor

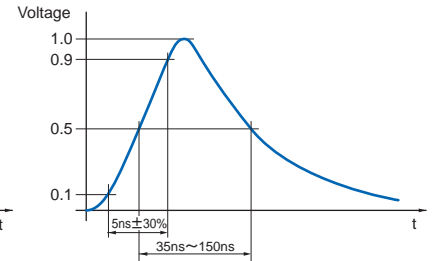
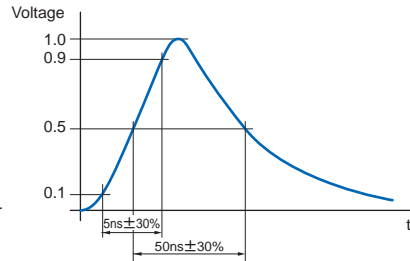

- General graph of a fast transient at a 50Ω load

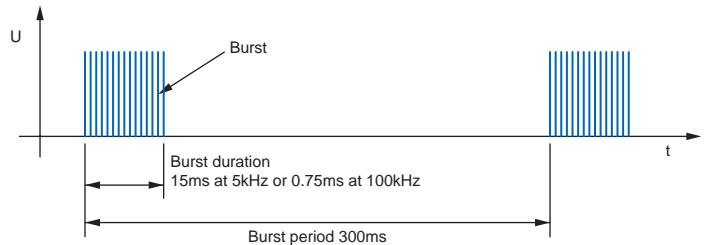
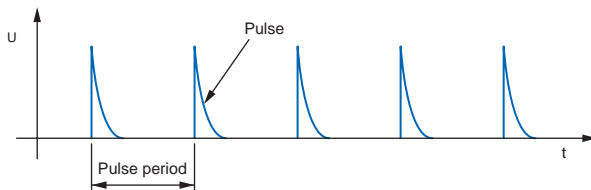

- Construction of the capacitive coupling clamp

This clamp provides the ability to couple the fast transient/burst signals to the circuit under test without any direct connection to the EUT port.

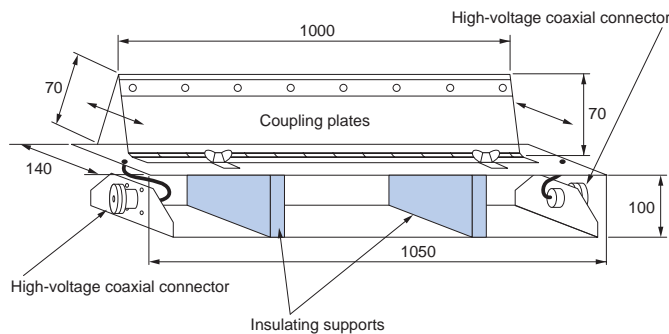

- Test levels

4 test levels applicable to power supply including protective earth, I/O, data and control ports are specified. These values are open-circuit voltages which shall be indicated by the simulator's meter.

Open-circuit test voltage and repetition rate of the pulses				
Level	Power supply port PE		I/O signal, data and control ports	
	Voltage peak(kV)	Repetition rate(kHz)	Voltage peak(kV)	Repetition rate(kHz)
1	0.5	5 or 100	0.25	5 or 100
2	1	5 or 100	0.5	5 or 100
3	2	5 or 100	1	5 or 100
4	4	5 or 100	2	5 or 100
X	special	special	special	special

- Coupling/decoupling network for a.c./d.c. power mains supply ports/terminals

This network provides the ability to apply the test voltage in common mode (lines-to-ground mode) to the power supply port of the EUT without affecting other equipment.

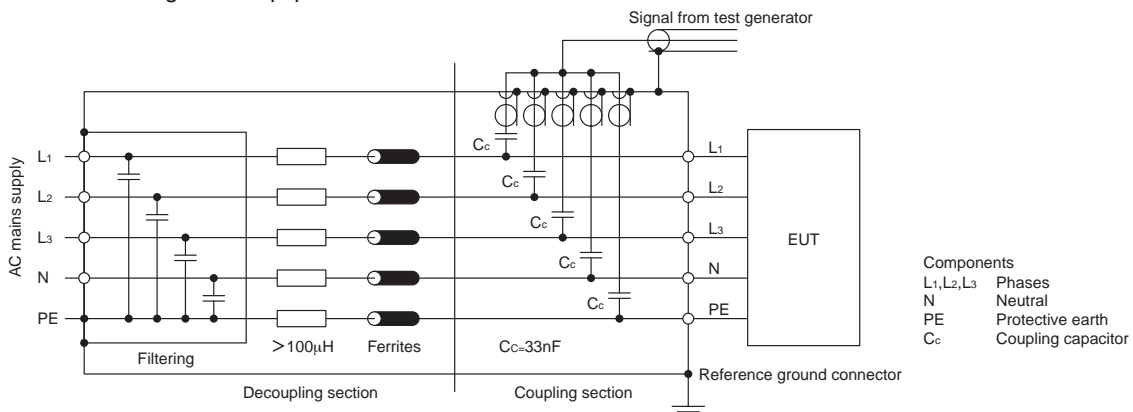

Components
 L₁, L₂, L₃ Phases
 N Neutral
 PE Protective earth
 C_c Coupling capacitor

IEC 61000-4-4 STANDARD / BASIC EMC PUBLICATIONS

- Test set-up and conditions
 - Two different types are distinguished:
 - Type test performed in a laboratory
 - Post-installation tests performed on equipment in its final installed condition.
- The test set-up includes:
 - Ground reference plane- copper/aluminum sheet of 0.25 mm minimum thickness. Other material may be used but the minimum thickness shall be 0.65 mm
 - Burst generator
 - CDN/coupling clamp

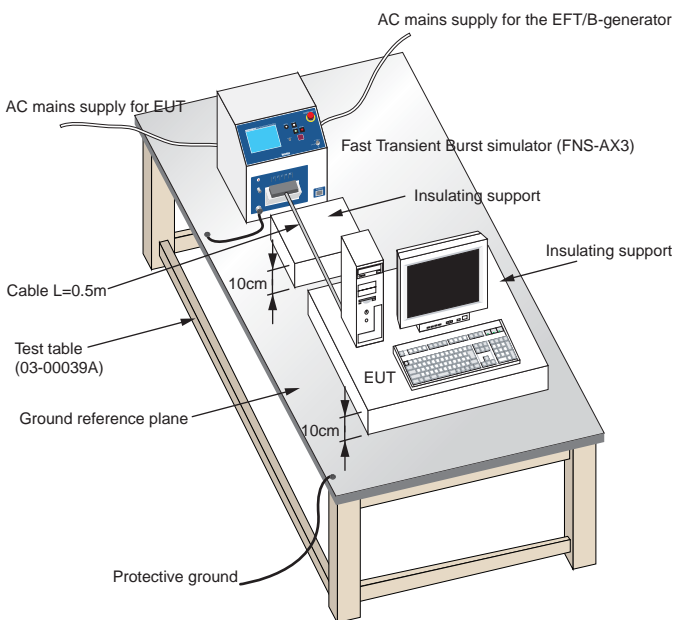

General test set-up A for laboratory type tests

- Test set up for type test
 - The EUT shall be placed on a ground reference plane and shall be insulated from it by an insulating support of 0.1 m thickness.
 - The minimum size of the plane is 1 m by 1 m. The actual size depends on the dimensions of the EUT. The plane shall project beyond the EUT by at least 0.1m on all sides
 - The plane shall be connected to the protective earth.
 - The EUT including grounding connection shall be arranged according to the manufacturer's installation guide or specifications.
 - The minimum distance between the EUT and all other conductive structure shall be 0.5m.
 - The connection of the generator ground to the reference ground plane shall be of low impedance.
 - The length of the signal and power lines between the coupling clamp or CDN output and the EUT shall be 0.5 m. If the manufacturer provides a non-detachable supply cable longer than 0.5 m, the excessive length shall be folded to avoid a flat coil.

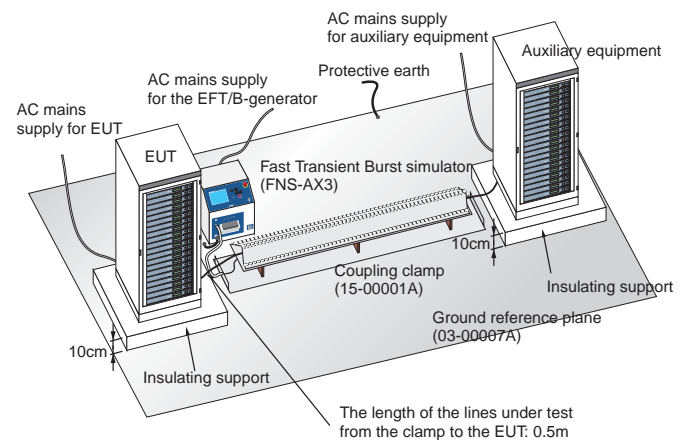

General test set-up B for laboratory type tests

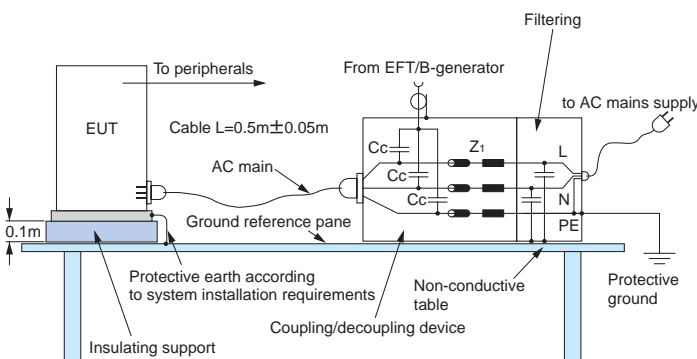

Example of a test set-up for application of the tests voltage to AC power supply ports by the coupling/decoupling network

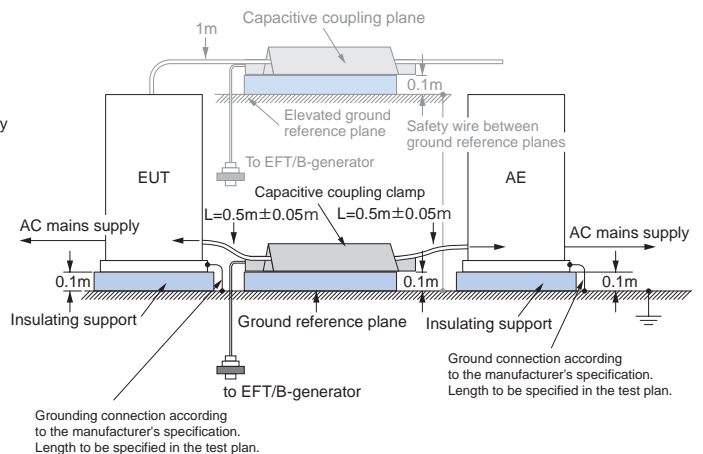

Example of test set-up for application of the test voltage by the capacitive coupling clamp

FNS-AX3 series

PRECISE AND STABLE OUTPUT WAVEFORM

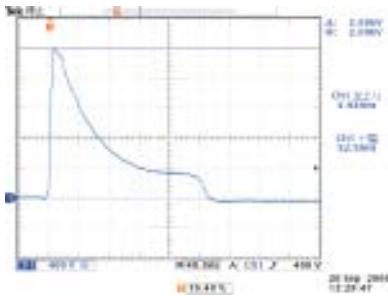

Pulse waveform at the generator output (PULSE OUT), 50Ω terminated

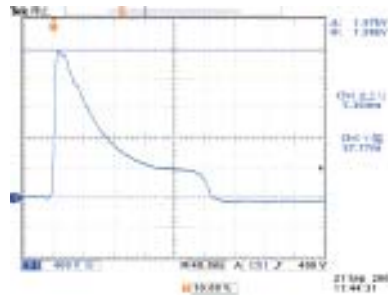

Pulse waveform at an output of CDN (EUT LINE OUTPUT), 50Ω terminated

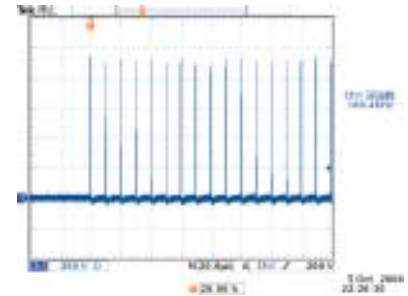

Repetitive pulses/burst

OPTIONS

EMS Probe Kit H2-B

A diagnostic tool for locating sensitive spots on the circuits under test to the electric or magnetic transient fields.

Features

- Detects possible noise immunity problem spots
- Generates transient electrical and magnetic fields separately
- Application for modules, components, conductors and ICs
- Suited for the connection to the FNS or INS series simulator
- Convenient handling by pencil shape, light plug-type cable with snap-acting coupling



Coupling clamp Model 15-00001A

Capacitive coupling clamp is optionally supplied. For interconnection line testing, connect the capacitive coupling clamp to the Pulse Out of the FNS-AX3 unit.

Features

- Coupling capacitance: 100~1000pF
- Coupling plates length: 1000mm



Attenuator Model AT-810/AT-811

50Ω coaxial attenuator for waveform verification

Features

- Attenuation : 40dB (DC~500MHz)
- Maximum input voltage: 4000V
- Input impedance: 50Ω(AT-810), 1kΩ(AT-811)



AT-810



AT-811

NOISE LABORATORY CO., LTD.

1-4-4 Chiyoda, Sagamihara, Kanagawa 229-0037 Japan
 TEL: +81-(0)42-712-2051 FAX: +81-(0)42-712-2050

<http://www.noiseken.co.jp>
 E-mail: sales@noiseken.com

Authorized representative