

Daqstation DXAdvanced DX1000/DX2000

www.daqstation.com

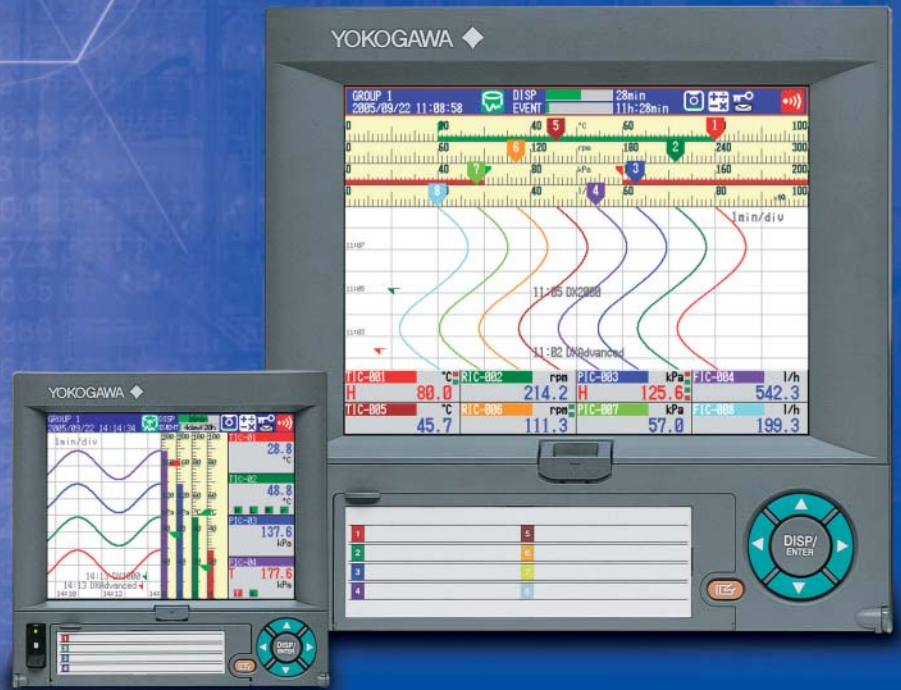

DXAdvanced[®] ***DX1000/DX2000***

Daqstation

Introducing New Functions for Firmware **R2** (Release 2)

The following are the main functions added with **DXAdvanced R2**

- MW100 Automatic Assignment Function (DX2000/MC1 Option)
- Media FIFO Function
- Other improved operability

Bulletin 04L41B01-01E

www.daqstation.com

Envision a plant...

vigilantplant.TM

The clear path to operational excellence

VigilantPlant excels at bringing out the best in your plant and your people - keeping them fully aware, well informed, and ready to face the next challenge. **DXAdvanced** is a core building block of Yokogawa's VigilantPlant solutions that promise to bring operational excellence to visionary plants.



DX2000

Introducing the new DX Series DXAdvanced[®]



DX1000

Advanced reliability Enhanced Reliability

- Dust and waterproof front panel
- Internal non-volatile memory with error correction function
- Front door lock and login functions

Advanced user functions Easy Setup and Display Navigation

- USB keyboard & remote control option for text entry
- Jump to a pre-set screen with the Favorite key

Advanced data access DAQSTANDARD Data Management Software Included

DAQSTANDARD Data Management Software Included

Advanced performance High Input Capacity and Fast Measurement Speed

- Up to 48 rear-panel Universal inputs on DX2000
- Up to 348 inputs using external I/O
- 25 ms scan on high-speed models

Advanced memory High Capacity Memory

- Up to 200 MB of internal non-volatile memory
- Available CompactFlash card removable storage media
- Optional USB port for keyboard and flash drive use

Advanced connectivity Advanced Networking Technology

- Built-in, standard Ethernet interface
- Web server, E-mail messaging, MODBUS TCP client/server, network time synchronization (SNTP), automatic network setup (DHCP), and more.

With unparalleled measurement, display, and connectivity functions, the new DXAdvanced data acquisition and display stations provide all-in-one data measurement, visualization and historian functions with no programming or costly integration. At the same time they can seamlessly integrate with your existing I/O and plant SCADA/HMI systems.

As the next generation DAQSTATION, DXAdvanced is built on years of field-proven performance with YOKOGAWA quality and reliability built-in.

Advanced Measurement Performance

DXAdvanced supports more input channels and faster measurement speeds to handle a greater number of applications.

A single DXAdvanced unit can operate as a stand-alone data recorder or as the central recording and display station for distributed multi-point data acquisition applications.

Multi-channel Measurement and Recording

The DX1000 and the DX2000 provide up to 12 or 48 Universal input channels respectively, providing high performance standalone recording functions. It can be used in various applications as an easy to use, traditional paperless recorder.

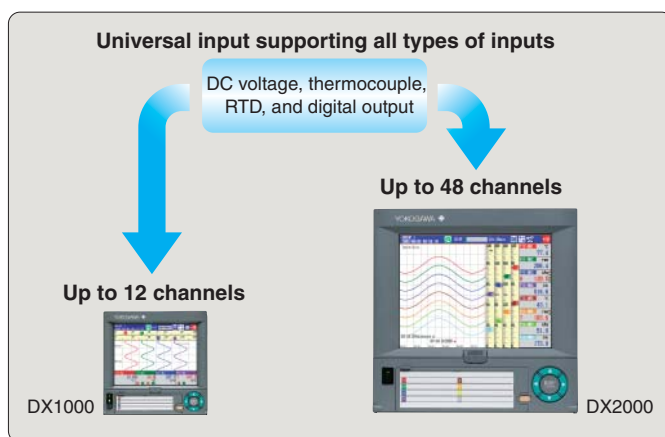

Scalable, High Input Capacity via External I/O

Using Modbus TCP communications, YOKOGAWA's MW100 data acquisition platform and other vendor's I/O products can be the source of many additional input channels. In this manner, up to 240 external channels can be input to DXAdvanced. Using optional math channels, 60 additional external inputs can be acquired for a total of 300. Start small and scale up your system by adding additional MW100 input modules, as you need them.

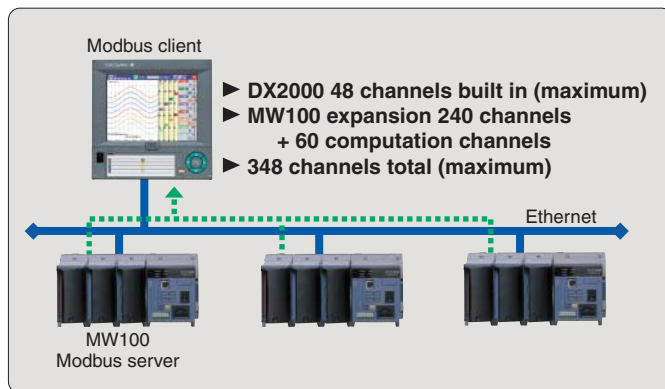

R2 New Function: MW100 Automatic Assignment Function*

When connecting MW100s to the DX2000 via Modbus/TCP, the channels of the MW100s (the Modbus servers) on the network are assigned to the DX2000 automatically. With just a simple operation, the MW100 channels are recognized and assigned to the DX expansion channels automatically, making Modbus register settings and other setup unnecessary. More easily than ever, you can take advantage a PC-free, distributed multipoint data acquisition system using the DX2000 and MW100s.

* This function only available on a DX2000 with the external input channel function (/MC1 option). Also, MW100s that support auto channel assignment are those with firmware version R2.22 or later.

High Speed Measurement

A new fast sampling mode on 2, 4, and 8 input DXAdvanced models provides a scan interval of 25 ms. All other models support a 125 ms scan speed in this mode. This capability allows all DXAdvanced models to capture and record fast-transient input signals.

Model	High-Speed Scan Interval (Fast sampling mode)	High-Speed Scan Interval (Normal mode)
DX1002, DX1004 DX2004, DX2008	25ms	125ms
DX1006, DX1012 DX2010~DX2048	125ms	1s

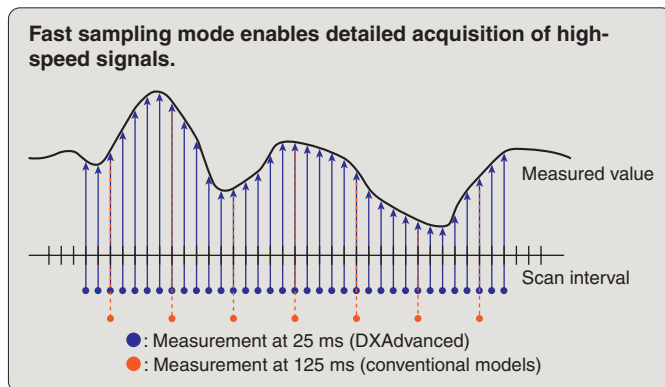

Greatly increased memory capacity supports uninterrupted recording for more channels over longer time periods.

Highly reliable and secure data storage is achieved with large capacity flash memory technology for both internal memory and removable storage media.

High Capacity Internal Memory

DXAdvanced supports up to 200 MB of non-volatile, internal flash memory. This secure, reliable memory can hold almost 3 years of data (30 channels at 1 minute sample rate), with capacity in reserve for any recording application.

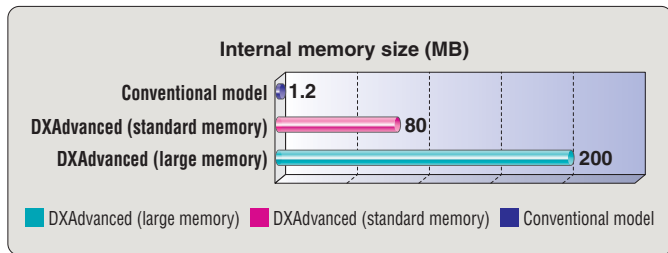

* The maximum number of files that can be created in the internal memory is 400.

Display data file sample time

Measurement CH = 30 channels. Computation CH = 0 channels.

	DX2000 (200 MB)	Conventional model (1.2 MB)
Display update (minute/div)	30 minutes	
Save interval (s)	60 s	
Total sample time	Approx. 1085 days	Approx. 6 days

Event data file sample time

Measurement CH = 30 channels. Computation CH = 0 channels.

	DX2000 (200 MB)	Conventional model (1.2 MB)
Save interval (s)	1 s	
Total sample time	Approx. 34 days	Approx. 5.6 hours

CompactFlash Removable Storage Media

All DXAdvanced models include a CompactFlash drive. Rugged and readily available CompactFlash cards (CF cards) serve as the removable media, and are available as optional accessories. Up to 2 GB CF card supported.

R2 New Function: Media FIFO Function

This function ensures that the CF card always retains the latest data when files are saved to it automatically. When the CF card is full, the oldest files are deleted to make room for the newest files. The media FIFO function allows you to use the DX continuously for long periods of time without having to change the CF card.

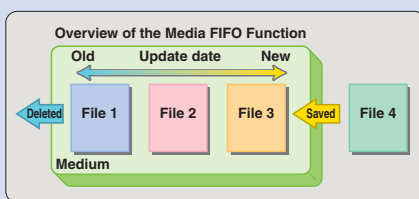

Optional USB Flash Drive

A USB flash drive can now be used to transfer data to your PC. The optional front panel USB port also allows an external PC keyboard to be used with the DXAdvanced to facilitate setting and text entry.



Advanced Display and User Interface

With outstanding display clarity and brightness, DXAdvanced gives life to process data with a multitude of standard display screens. Front panel text entry and setup can be carried out quickly and easily using a USB keyboard* or remote control unit.*

*optional

CompactFlash card (CF card) slot

Insert a CF card to save data.

USB port

Optional front and rear panel USB ports allow the use of USB flash drive and a full size PC keyboard*.

* USB flash drive and USB keyboard are not included.



DX1000

Remote control unit

Enables the DXAdvanced to be controlled remotely (option).



Display mode menu

Press the DISP key in the operation keys to show a pop-up display mode menu. Then, simply select a menu using the operation keys to switch the display mode.

Key panel

The key panel contains function keys, memory sampling START/STOP keys, and a numerical key pad (DX2000 only). These keys are primarily used to perform various actions related to data recording, and to enter settings in the DXAdvanced.

Power switch

Turn the power ON/OFF from the front panel of the DXAdvanced.



Flexible and Intuitive Display Modes

All operation screens can be accessed by using the operation keys.

In addition, the Favorite key enables instant access to an operation screen that is selected in advance.

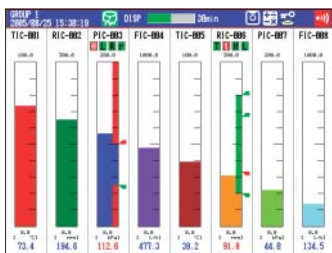

– Bar graph display –

Vertical or Horizontal bar graph can be selected in the bar graph display mode.



– Large-font digital display –

The digital display mode shows measured data as numeric values, and displays channel number, tag name, engineering units, and alarm status.

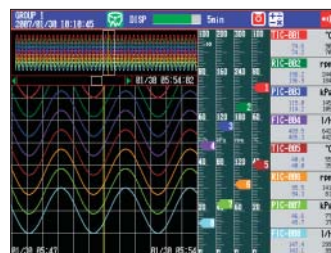

– Historical trend display –

This display mode allows you to display historical data stored in memory. From the overview display, select the area you want to view and jump to a historical trend of the data.



– Split screen display –

This mode lets you split the screen into four areas, and select the display format for each of the areas.



– Circular Display –

In addition to the normal T-Y trend display, circular display is possible (DX2000 only).



– Overview display –

This screen lets you monitor the alarm statuses and numeric value for all channels.

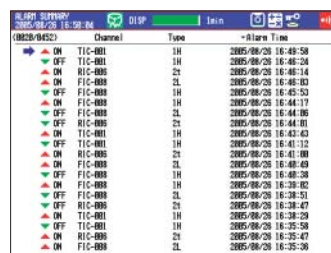

– Information display –

This information screen displays alarm summary, message summary, memory information or media information.

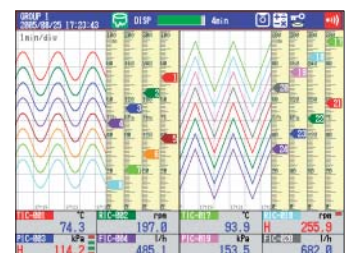

– Horizontally Divided Trend Display –

Horizontally divides the trend display into two screens enabling waveform comparison of different channels.



YOKOGAWA

DXAdvanced status display area

This area graphically presents the DXAdvanced operating status.

Trend display area

This area displays Trend Lines, together with scale values and engineering units for each channel along with user selectable messages.

Digital display area

This area displays digital measurement values, together with channel or tag numbers, industrial units, and alarm statuses for each channel.

Scale display area

Scales the measured values of each channel. Green band, alarm mark, or bar graph can be displayed on the scale display.

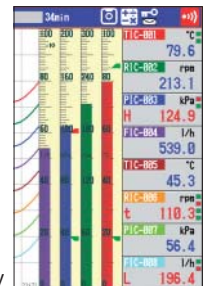

Bar graph on scale display

Navigation keys

The Navigation keys are used for functions such as switching display modes, primarily during normal operations (in operation mode). When entering settings, the Navigation keys are used to move the cursor.

Favorite key

Press the Favorite key to instantly switch to the display mode selected in advance.

Status Display LED and Remote Control Sensor

LEDs indicating power on and recording start/stop illuminate. In addition, a remote control sensor is built in (option).

DX2000

Customize Operation Menus

Operation menus can be customized. Unneeded menu items can be hidden.

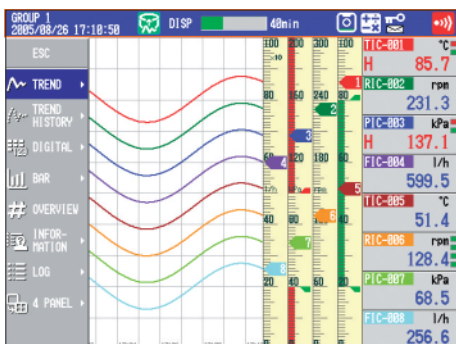

– Before customization –

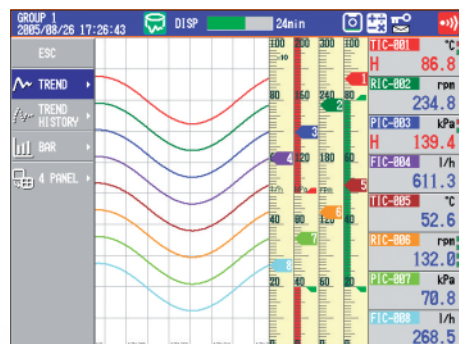

– After customization –

Advanced Ethernet Connectivity

The Ethernet interface standard on all DXAdvanced models includes powerful connectivity and convenience functions that make access to important information easier than ever.

Networking Functions

[FTP data transfer]

The FTP client function in the DXAdvanced will automatically transfer, at preset times, data files saved to the DXAdvanced unit's internal memory. Both a primary and secondary server can be specified. If a transfer to the primary server fails, files will automatically be transferred to the secondary server.

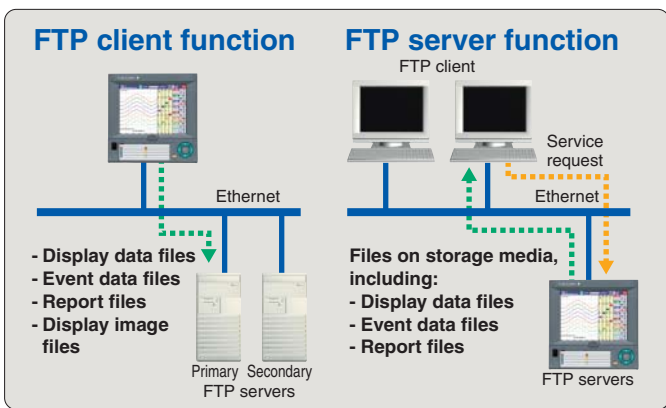

[DXAdvanced web server functions]

DXAdvanced display screens can be displayed on common web browsers such as Internet Explorer. In addition to displaying screen displays, your web browser can check alarm status, report instantaneous channel values, and write message data to the DXAdvanced. This capability allows data on any DXAdvanced unit to be displayed on any PC in the plant or anywhere outside the plant with Internet access to the facility.

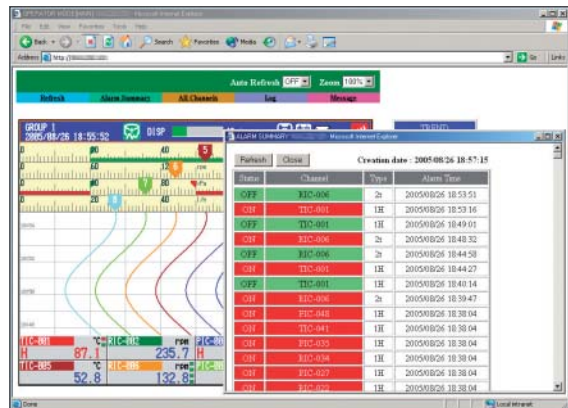

[E-mail messaging functions]

The DXAdvanced can send a variety of informative e-mail messages that include alarm notification reports, periodic instantaneous data values, scheduled report data and other information.

With Internet access, DXAdvanced can send e-mail messages anywhere in the world. An e-mail-capable cellular phone can be used to receive instantaneous remote notification of alarms.

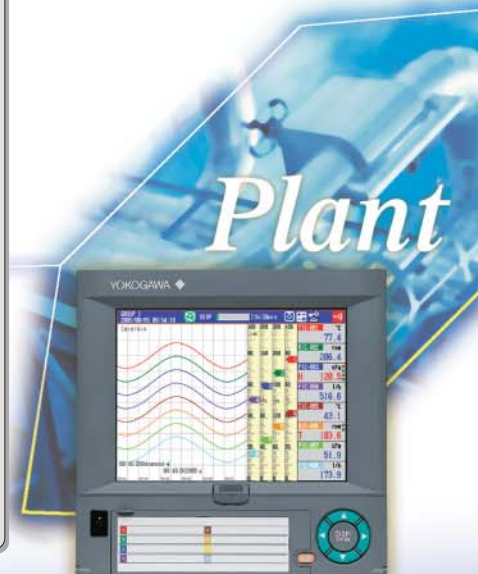
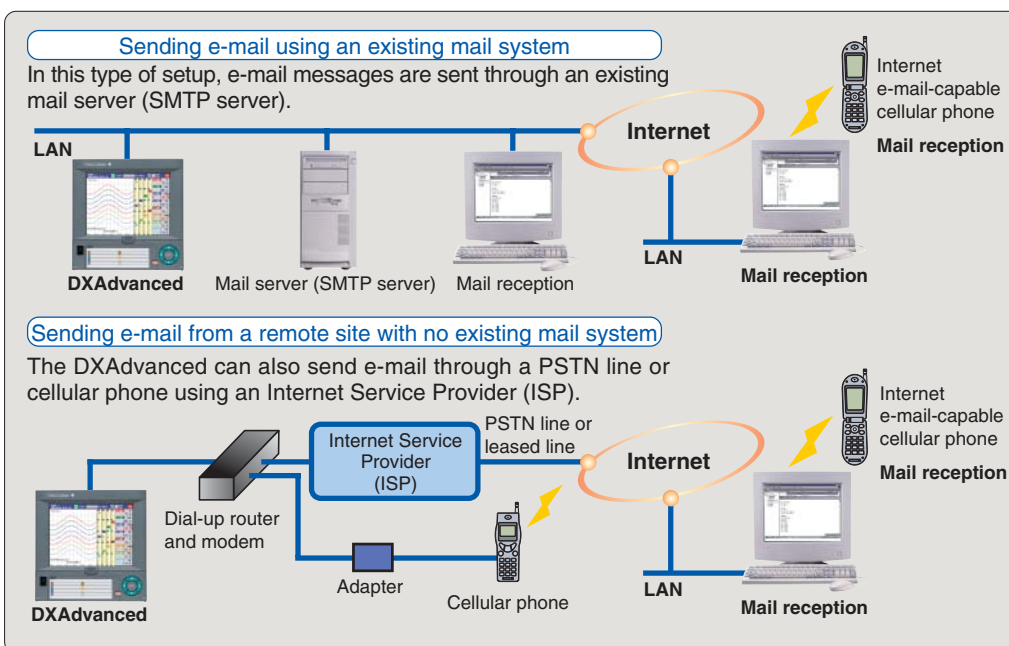

[Time Synchronization with Network Time Servers]

DXAdvanced uses SNTP protocol in client mode to acquire time information from a network time-server. This function allows any number of DXAdvanced units within a facility to have precisely synchronized time; so all units will record data with coordinated date and time stamp information. In addition, DXAdvanced can function as a server, providing time data to other SNTP client units on the network.

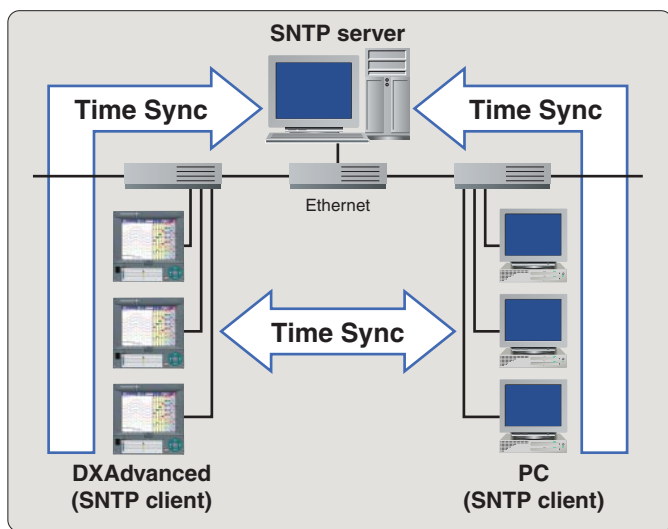

[Automatic Network Setup (DHCP) Function]

Using Dynamic Host Configuration Protocol (DHCP), the DXAdvanced can automatically acquire the settings it needs (IP address) for network communications from a DHCP server. This makes it easier than ever to install the unit on a plant network.

When the DXAdvanced is connected to a network, it automatically obtains network-setting parameters such as the IP address from a DHCP server. It also automatically registers the host name to a DNS server.

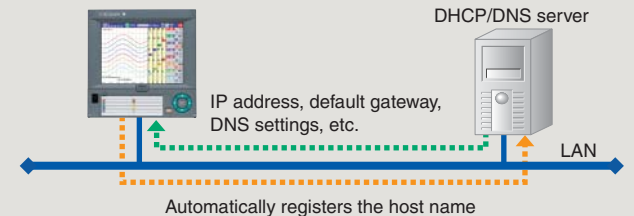

[Modbus TCP] and [Modbus RTU] Communications

DXAdvanced supports MODBUS TCP/IP client and server modes for Ethernet communications and MODBUS RTU master and slave modes for optional serial communications. Both allow large amounts of external data points to be input to and processed by the DXAdvanced from external hardware such as YOKOGAWA's MW100. With this capability, a multi-point data acquisition system of up to 348 channels can be configured*. This bi-directional communication also allows the DXAdvanced to provide data to other devices such as a PLC.

* External input option and mathematical functions option are required.

Modbus TCP (Ethernet connection)

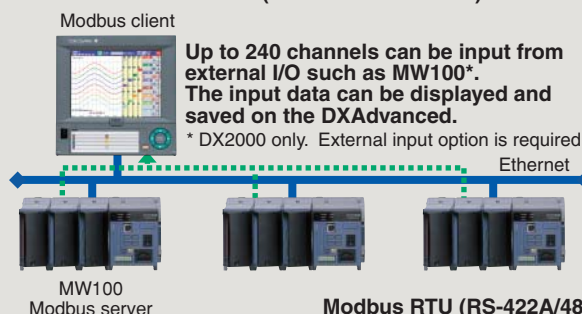

Modbus RTU (RS-422A/485 connection)

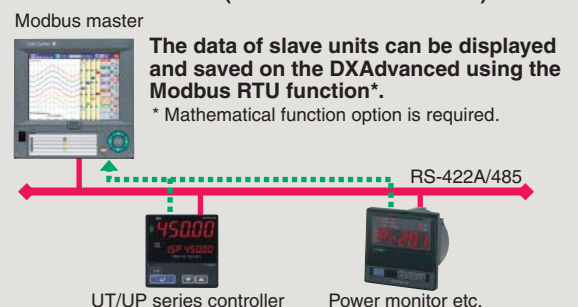



Advanced Reliability and Security

High quality and reliability are part of YOKOGAWA's DNA.

Security measures within DXAdvanced safeguard important data and limit system access to authorized users.

High Level Security Functions

[Secure, Binary Data File Format]

Measured data is saved in a proprietary, binary file format that is resistant to tampering with common software applications. The viewer software generates a message to warn the user if the data file is damaged or modified in any way.

ASCII data display

20"	0.007	0.035	0.071	0.001	-0.004
22"	-0.178	-0.007	-0.175	-0.074	-0.004
24"	-0.272	-0.178	-0.275	-0.175	-0.005
26"	-0.371	-0.272	-0.275	-0.275	-0.005
28"	-0.464	-0.371	-0.468	-0.375	-0.004
30"	-0.558	-0.464	-0.556	-0.468	-0.004
32"	-0.649	-0.558	-0.639	-0.556	-0.004
34"	-0.719	-0.649	-0.722	-0.639	-0.004
36"	-0.793	-0.719	-0.797	-0.722	-0.005
38"	-0.859	-0.793	-0.859	-0.797	-0.005
40"	-0.944	-0.859	-0.919	-0.859	-0.005
42"	-0.966	-0.915	-0.968	-0.919	-0.003
44"	-1.000	-0.966	-1.000	-0.968	-0.002
46"	-1.001	-1.000	-1.000	-1.000	-0.002
48"	-1.001	-1.001	-1.001	-1.001	-0.001
50"	-1.002	-1.001	-1.002	-1.001	-0.002
52"	-1.002	-1.002	-1.002	-1.002	-0.001
54"	-1.002	-1.002	-1.002	-1.002	-0.001
56"	-1.002	-1.002	-1.002	-1.002	-0.001
58"	-1.002	-1.002	-1.002	-1.002	-0.001
60"	-1.001	-1.001	-1.001	-1.001	-0.001
62"	-0.978	-0.978	-0.968	-0.929	0.002
64"	-0.929	-0.929	-0.929	-0.929	0.002
66"	-0.875	-0.875	-0.875	-0.875	0.002
68"	-0.802	-0.802	-0.802	-0.802	0.002

Binary data display

[Key Lock Function]

A password-protected key lock can be applied to each operation key or for access to the external storage media.

[Highly Reliable Internal Flash Memory]

Reliable, non-volatile flash memory is used for internal data storage operations with ECC* function. DXAdvanced retains important data during power failures of any duration with no battery protection circuit needed.

* ECC: Error Check and Correct

[Data Redundancy]

Measured and calculated data is continuously saved to secure, internal non-volatile flash memory. At manual or scheduled intervals, the files in memory are copied to the removable media, which is also secure flash memory. In addition, the files can be copied and archived to an FTP server. Because of the inherent reliability and security of flash memory and the storage methods used, the possibility of losing data under any operating condition or power failure event is extremely small. When FTP transfer functions are used, three copies of the same data file can exist at the same time in three locations, thus providing a high level of redundancy.

[Login Function]

This function enables only registered users to access the DXAdvanced. Five administrators and 30 common users can be registered in advance. A user can login by entering their user name, user ID, and password.

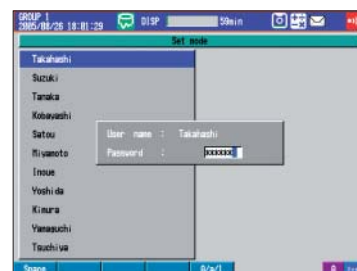

[Front Door Lock]

A mechanical lock with removable key is provided to securely latch the front panel door. This forbids access to the power switch and removable media.

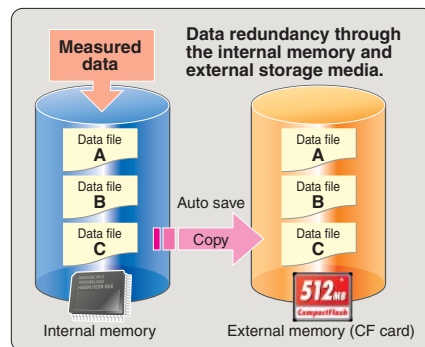

Robust Hardware

[Dust-proof and water-proof front panel (IEC529-IP65, NEMA No.250 TYPE4* compliant)]

YOKOGAWA designed the DXAdvanced to be used under harsh environmental conditions. The front panel has a dust-proof, water-proof design which is compliant with the IEC529-IP65 and NEMA No.250 TYPE4* standard. This structure provides good protection for the recorder's internal components as well as the removable storage media drive mechanism.



* Except external icing test.

[High-breakdown-voltage solid-state relays]

DXAdvanced uses high-breakdown-voltage solid-state relays developed by YOKOGAWA as scanners for switching input signals. These relays consist of MOSFETs capable of withstanding high voltage (1500 V DC) with low leakage current (3 nA), and power-output photocouplers. They provide high-speed scanning (125 ms/48 channels in the DX2048) while increasing scanner life and eliminating noise.



[Isolated channel inputs]

DC voltage and thermocouple inputs in all DXAdvanced models are channel-isolated. (Channel isolation for RTD inputs is optional on some models.) The high common mode noise characteristic enabled by isolated channel inputs ensures stable measurements in a wide range of applications.

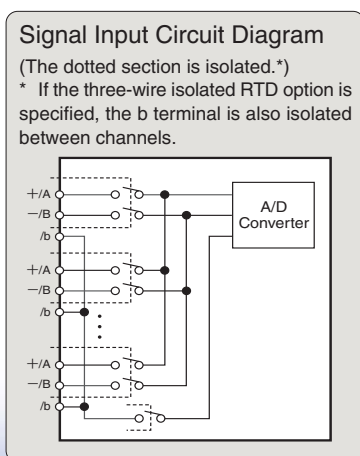

[4 mm removable screw input terminals]

Input terminals are the "entryways" through which all measurements enter a recorder. A reliable mechanical connection to the field wiring is critical for stable data collection. Rugged 4 mm screw input terminals are used on all DXAdvanced models. Input terminals can also be removed with the wiring attached to facilitate installation and maintenance.



DX1000



DX2000

[Removable clamp input terminal]

The removable clamp input terminal is available with the option (/H2). As this terminal is removable, it makes it very easy to change sensors such as thermocouples frequently.



[Compliance with safety standards and EMC standards]

Another indication of the reliability of DXAdvanced is their compliance with the stringent specifications for international safety and electromagnetic compatibility (EMC) standards. Of course, DXAdvanced have also been approved for the CE standards.



YOKOGAWA EMC laboratory

CSA: CSA22.2 No61010-1, installation category II, pollution degree 2
UL: UL61010-1 (CSA NRTL/C)
CE: EMC directive: EN61326 compliance (Emission: Class A, Immunity: Annex A)
EN61000-3-2 compliant
EN61000-3-3 compliant
EN55011 compliant, Class A Group 1
Low voltage directive: EN61010-1 compliant, measurement category II, pollution degree 2
C-Tick: AS/NZS CISPR11 compliant, Class A Group 1



Advanced PC Software for Data Management and Reporting

Maximize the capabilities of DXAdvanced with easy to use PC software.

DAQSTANDARD for DXAdvanced (Compatible with Windows 2000/XP)

DAQSTANDARD is a standard software package included with the DXAdvanced. It can be used to print or redisplay historical data files saved by the DXAdvanced unit or transferred through FTP.

[Data Viewer]

The Data Viewer module can be used to display and print data in files generated by the DXAdvanced unit. Data can be viewed in trend displays, digital displays, circular displays, and lists. In addition, the cursor can be used to read numerical values in displayed data, or to make interval calculations. Data can be converted to ASCII, or to file formats that can be opened in Excel or Lotus 1-2-3.

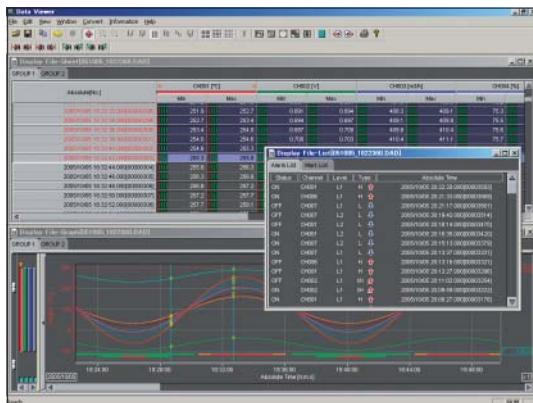

Data Viewer

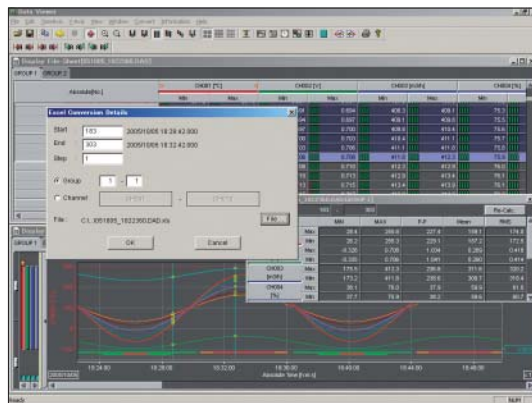

Data conversion window

[Hardware Configurator]

All DXAdvanced configuration settings can be modified on-line via the network connection using the hardware configurator tool. This allows the user to configure the unit quickly and easily from a PC. In addition, an off-line configuration can be performed where the settings are saved to a file on the removable media, and then taken to the unit and loaded via the media drive. A catalog of setting files can be archived on both the PC and the unit for future use or modification.

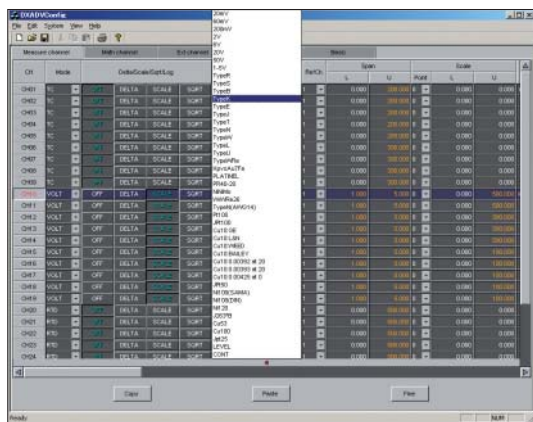

Measurement channel setting

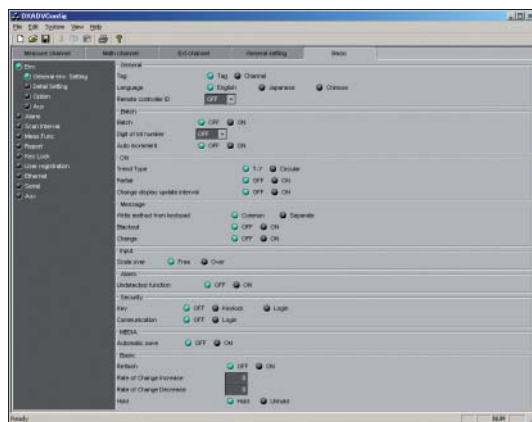

Environment setting

DAQWORX



DAQWORX is a data acquisition system software suite that integrates YOKOGAWA recorder, data logger, and controller instruments. It can be used to configure scalable systems from small-scale network instrumentation to distributed, multi-channel data acquisition.



[DAQLOGGER] (Compatible with Windows 2000/XP)

A data logging software application that enables Ethernet and serial communication to be used simultaneously. A mixture of DXAdvanced's, DARWIN data acquisition units, and uR recorders can be combined (32 units total) to achieve data acquisition of 1600 channels.

• **Manager module**

The Manager module is used for starting modules such as the Setup module and file utilities. It is also used to enter Event Processor settings, and to start, run, and stop data acquisition.

• **Data Monitor module**

The Data Monitor module allows you to monitor measurement data and calculations in a variety of formats. Available formats include trend display, digital value display, and meter display.

• **Event Processor**

The Event Processor automatically performs actions such as sending email, FTP file transfer, PNG file output, and file conversion when a specified event occurs (e.g., alarm, file creation, or preset time).

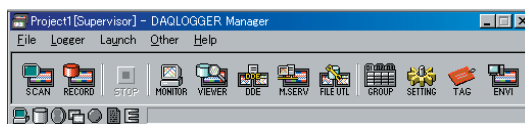

Manager

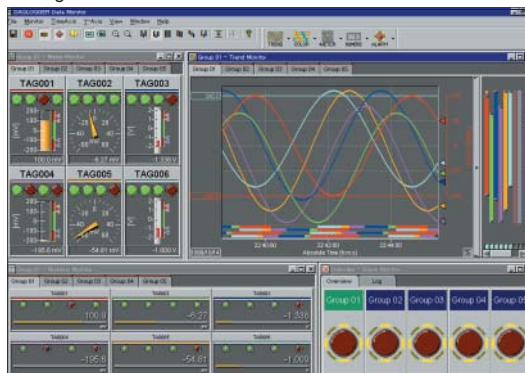

Data Monitor



[DAQEXPLORER] (Compatible with Windows 2000/XP)

DAQEXPLORER is a desktop file manager program that allows the user to view a directory of the local internal memory on each DXAdvanced unit, and then move files to the PC on-demand across the network connection. In addition, the program includes the viewer functions of the DAQSTANDARD software, plus a real-time data monitoring display mode and other convenience functions. This optional software is highly recommended for all networked applications.

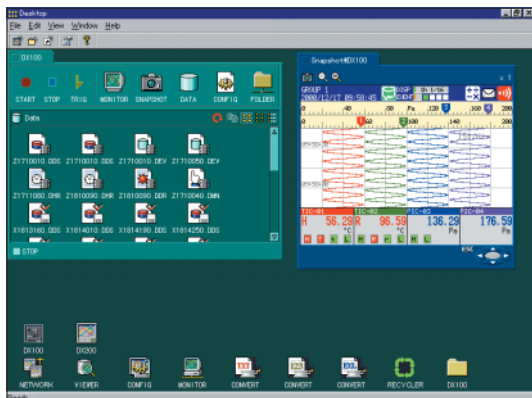

Desktop

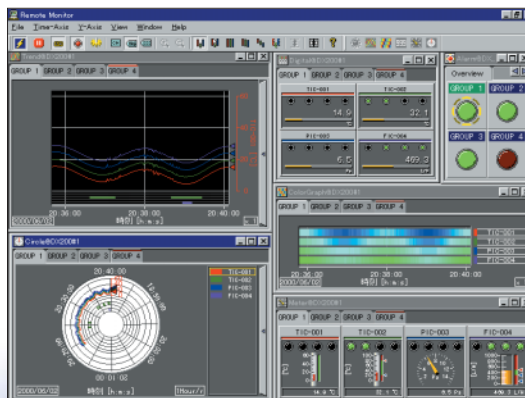

Data Monitor

STANDARD SPECIFICATIONS

General Specifications

- Construction
 - Mounting: Flush panel mounting (on a vertical plane)
Mounting may be inclined downward up to 30 degrees from a horizontal plane.
 - Allowable Panel Thickness: 2 to 26 mm
 - Front Panel: Water and dust-proof
(based on IEC529-IP65 and NEMA No.250 TYPE4*)
* Except external icing text.
- Input
 - Number of Inputs:
 - DX1000: 2, 4, 6, 12 channels
 - DX2000: 4, 8, 10, 20, 30, 40, 48 channels
 - Measurement Interval:
 - DX1002, DX1004, DX2004, DX2008: 125 ms, 250 ms, 25 ms (fast sampling mode*)
 - DX1006, DX1012, DX2010, DX2020, DX2030, DX2040, DX2048: 1 s (Not available when A/D integration time is set to 100 ms), 2 s, 5 s, 125 ms (fast sampling mode*)
* A/D integration time is fixed to 1.67 ms in case of fast sampling mode.
(Note) In case of fast sampling mode (A/D integration time: 1.67 ms), the measured values may be susceptible to inaccuracies due to power supply frequency noise, etc. If this is the case, please use the normal sampling mode (A/D integration time: 16.7 ms, 20 ms or 100 ms).
 - Inputs:
 - DCV (20, 60, 200 mV, 2, 6, 20, 50 V, 1-5 V)
 - TC (R, S, B, K, E, J, T, N, W, L, U, WRe)
 - RTD (Pt100, JPt100)
 - DI (Contact input, TTL level)
 - DCA (With external shunt resistor attached)
- Display
 - Display unit:
 - DX1000: 5.5-inch TFT color LCD (320 x 240 pixels)
 - DX2000: 10.4-inch TFT color LCD (640 x 480 pixels)
 - Note) In the part of crystal display, there are some pixels that can't always turn on or off. Please understand that the brightness of screen looks uneven because of characteristics of crystal display, but it is not out of order.
 - Display group:
 - Number of display: DX1000: 10 groups, DX2000: 36 groups
 - Number of assignable channels for one group: DX1000: 6 channels, DX2000: 10 channels
 - Display color:
 - Trend/Bargraph: Selectable from 24 colors
 - Background: White or black selectable
 - Trend display:
 - Trend display type: Vertical, horizontal, landscape, horizontal split or circular* selectable
* Circular display is only for DX2000.
 - Bargraph display:
 - Direction: Vertical or horizontal selectable
 - Digital indication:
 - Display renewal rate: 1 s
 - Overview display:
 - Number of indication channels: Measuring values and alarm status of all channels
 - Information display: Alarm summary, message summary, memory information, report information, relay status, Modbus status
 - Tags:
 - Number of characters: 16 characters maximum
 - Messages:
 - Number of characters: 32 characters maximum
 - Number of messaged: 100 messages (including 10 free messages)
 - Data referencing function: Display the retrieved data (display data or event data) from internal or external memory.
- Data Saving Function
 - External storage medium:
 - Medium: CompactFlash memory card (CF card)
 - Internal memory:
 - Medium: Flash memory
 - Capacity: Selectable from 80MB or 200MB
 - Maximum number of files can be saved: 400 files
(total number of display data file and event data file)
 - Manual saving: Data files in internal memory can be saved manually.
Selectable form all data saving or selected data saving.

- Automatic saving:
 - Display data: Periodic saving to CF card
 - Event data: In case of trigger free...Periodic saving to CF card
In case of using trigger...Save the data when sampling is finished
- Data Saving Period:
 - Display data file: Linked with the waveform span rate
 - Event file: Linked with the specified sampling period
- Display hard copy:
 - Trigger: Key operation, communication command or event action function
- Data file retrieving function: Data file in CF card or USB memory (only for USB option) can be retrieved and displayed.
- Alarm Function
 - Number of alarm levels: Up to four levels for each channel
 - Alarm types: High and low limits, differential high and low limits, high and low rate-of-change limits and delay high and low
 - Display: The alarm status (type) is displayed in the digital value display area upon occurrence of an alarm. A common alarm indication is also displayed.
 - Alarming behavior: non-hold or hold-type can be selectable for common to all channels.
- Event action function
 - General: Particular action can be executed by particular event.
 - Number of event action: 40 actions can be set
- Security functions
 - General: Login function or key lock function can be set for each key operation or communication operation.
 - Key lock function: On/off and password can be set for each operation key and FUNC operation.
 - Login function: User name and password to login can be set.
- Clock
 - Clock: With calendar function (year of grace)
 - Clock accuracy: ± 10 ppm, excluding a delay (of 1 second, maximum) caused each time the power is turned on.
 - DST function (summer/winter time): The time at which the daylight savings time adjustment is automatically calculated and configured.
- Communication Functions
 - Connection: Ethernet (10BASE-T)
 - Protocols: TCP, UDP, IP, ICMP, ARP, DHCP, HTTP, FTP, SMTP, SNTP, Modbus, DX private
 - E-mail inform function: E-mail is sent by events as alarm occurring, etc.
 - FTP client function: Data file auto-transfer from DX
 - Transferred data file: Display data file, event data file, report data file and display image file
 - FTP server function: File transfer from DX, file elimination, directory operation and file list output are available by request from host computer.
 - Web server function: Display image of DX and alarm information can be displayed on web browser software
 - SNTP client function: The time on DX can be synchronized to the time of a SNTP server.
 - SNTP server function: The DX can operate as a SNTP server.
 - DHCP client function: Network address configuration can be obtained automatically from DHCP server.
 - Modbus client function: Reading or writing of measurement data on other instruments are available by Modbus protocol.*
* /M1 option or /MC1 option is required to read data from other instrument.
 - Modbus server function: Output of measurement data on DX is available by Modbus protocol.
- Batch function
 - General: Data display and data management with batch name, text field function and batch comment function are available.
- Power Supply
 - Rated power supply: 100 to 240 VAC (automatic switching)
 - Allowable power supply voltage range: 90 to 132 or 180 to 264 VAC
 - Rated power supply frequency: 50/60 Hz (automatic switching)
 - Power consumption: DX1000: 60 VA (max., for 240 VAC power supply)
DX2000: 100 VA (max., for 240 VAC power supply)

Normal Operating Conditions

Power voltage:	90 to 132 or 180 to 250 VAC
Power supply frequency:	50 Hz \pm 2%, 60 Hz \pm 2%
Ambient temperature:	0 to 50 °C
Ambient humidity:	20% to 80% RH (at 5 to 40 °C)

SPECIFICATIONS OF OPTIONAL FUNCTIONS

- Alarm Output Relays (/A1, /A2, /A3, /A4*, /A5*)**
 An alarm signal is output from the rear panel as a relay contact signal.
 Number or output: Select from 2, 4, 6, 12* and 24* points
 * Only for DX2000.
- Serial Communication Interface (/C2, /C3)**
 Connection: EIA RS-232 (/C2) or RS-422A/485 (/C3)
 Protocols: DX private protocol, Modbus(master/slave) protocol
 Setting/measurement server function:
 Operation, setting or output of measurement data are available by DX private protocol.
 Modbus communication: Reading or writing of measurement data on other instruments are available by Modbus protocol.*
 * /M1 option or /MC1 option is required to read data from other instrument.
- VGA Video Output (/D5)**
 Resolution: 640 x 480 pixels (VGA)
- Fail/Status Output (/F1)**
 The relay contact output on the rear panel indicates the occurrence of CPU failure or selected status.
- Fail & Alarm Output Relays 22 points (/F2, only for DX2000)**
 Combination of "Fail/Status output function" and "Alarm output relays 22 points".
- Clamped Input Terminal (/H2)**
 Clamped input terminal (detachable type) is used for input terminal.
- Desk Top Type (/H5[], /H5*)**
 Provides carrying handle and power cord.
 * /H5 is only for 24 VDC/AC power supply model (/P1), and does not include power code.
- Mathematical Functions (/M1)**
 Used for calculating data, displaying trends and digital values, and recording calculated data assigned to channels.
 Channel assignable to calculated data:
 DX1002, DX1004: 12 channels, DX1006, DX1012: 24 channels
 DX2004, DX2008: Up to 12 channels
 DX2010, DX2020, DX2030, DX2040, DX2048: 60 channels
 Operation:
 General arithmetic operations:
 Four arithmetic operations, square root, absolute, common logarithm, natural logarithm, exponential, power, relational operations (>, \geq , <, \leq , =, \neq), logic operations (AND, OR, NOT, XOR)
 Statistical operations: TLOG (Average, maximum, minimum, summation and P-P value of time series data)
 CLOG (Average, maximum, minimum, summation and P-P value of channel series data)
 Special operations: PRE, HOLD(a):b, RESET(a):b, CARRY(a):b
 Conditional operation: [a?b:c]
 Constant: Up to 60 constants (K01 to K60)
 Report functions:
 Report type: Hourly, daily, hourly + daily, daily +weekly and daily + monthly
 Operation: Max. 4 types are selectable from average, maximum, minimum, instantaneous and summation
- Cu10, Cu25 RTD Input /3 leg isolated RTD Input (/N1)**
 This option allows Cu10 and Cu25 inputs to be added to the standard input types.
- 3 legs Isolated RTD Input (/N2*)**
 A, B, b legs are of isolated input type.
 * Only for DX1006, DX1012, DX2010, DX2020, DX2030, DX2040 and DX2048.
- Extended Input Types (/N3)**
 This option allows extra inputs types as below to be added to the standard input types.
 TC: Kp vs Au7Fe, PLATINEL, PR40-20, NiNiMo, W/Wre26, TypeN (AWG14)
 RTD: Pt25, Pt50, Ni100 (SAMA), Ni100 (DIN), Ni120, J263*B, Cu53, Cu100
- 24 VDC/AC Power Supply (/P1)**
 Rated power supply: 24 VDC or 24 VAC (50/60Hz)
 Allowable power supply voltage range:
 21.6 to 26.4 VDC/AC
 Max. power consumption:
 DX1000: 28 VA (24 VDC), 45 VA (24 VAC (50/60 Hz))
 DX2000: 45 VA (24 VDC), 70 VA (24 VAC (50/60 Hz))
- Remote Control (/R1)**
 This option allows eight functions to be controlled remotely by a contact input.
- 24 VDC transmitter power supply (/TPS2*, /TPS4, /TPS8*)**
 Output voltage: 22.8 to 25.2 VDC (rated load current)
 Rated output current: 4 to 20 mA DC
 * /TPS2 is only for DX1000, /TPS8 is only for DX2000

- Easy text entry (/KB1, /KB2)**
 Remote control terminal is available to operate the DX.
 Number of units that can be controlled:
 Max. 32 units by ID setting
- USB interface (/USB1)**
 USB interface specification: Based on Rev1.1, host function
 Number of ports: 2 ports (Front and rear panel)
 Available USB devices:
 Keyboard: 104/89 keyboard (US) based on USB HID Class Ver.1.1
 External medium: USB flash drive (Some of the USB flash drive may not be supported by DXAdvanced.)
- Pulse input (/PM1)**
 Pulse input option includes mathematical functions option (/M1) and remote control option (/R1).
 Number of inputs: 3 points (8 points are available in case of using remote inputs)
 Input format: Photocoupler isolation (shared common)
 Isolated power supply for input terminal (approx. 5 V)
- Calibration correction function (/CC1)**
 Corrects the measurement value of each channel using segment linearizer approximation.
 Number of segment points: 2 to 16
- External input function (/MC1, only for DX2000)**
 Digital input channels via communication are extended to input data from other instruments.
 Number of external input channels:
 Up to 240 channels (channel number: 201 to 440)
 * Only for DX2010, DX2020, DX2030, DX2040 and DX2048
 * Fast sampling mode is not available when external input option is equipped.

Dimensions

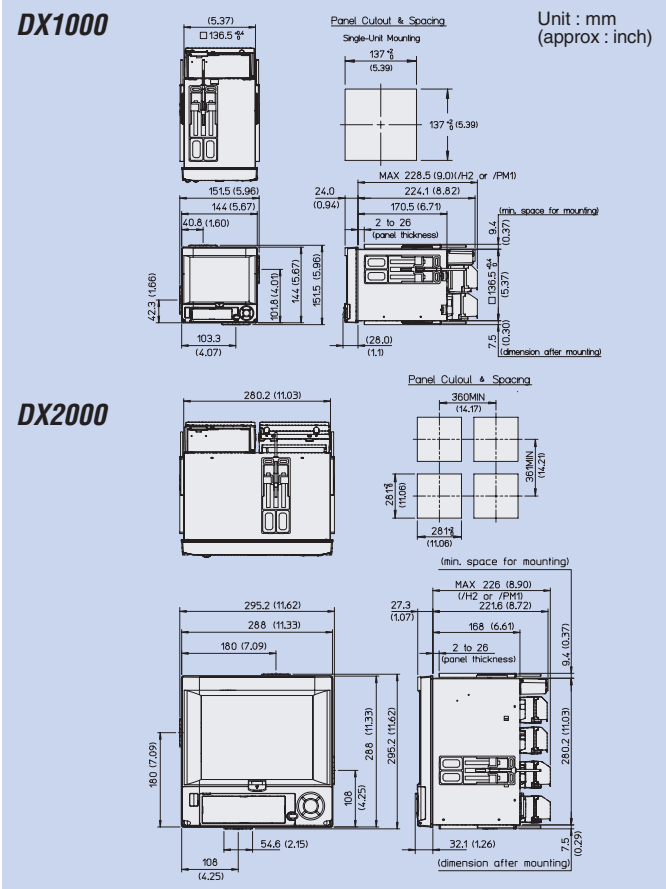

Two panel brackets are used in panel-mounting the DX1000 and DX2000. They may be used either on the left and right or top and bottom. See Yokogawa's General Specification (GS 04L41B01-01E) for information on panel cutting dimensions for DX1000 vertical or horizontal attachments. Unless otherwise indicated, tolerance is \pm 3% (or \pm 0.3 mm for dimensions under 10 mm).

Daqstation and DXAdvanced are registered trademark of Yokogawa Electric Corporation. Microsoft, MS, and Windows are registered trademarks or trademarks of Microsoft Corporation in the United States and other countries. Pentium are registered trademarks of Intel Corporation. Ethernet is a registered trademark of Xerox Corporation. Modbus is a registered trademark of AEG Schneider Automation Inc. Other company names and product names appearing in this document are registered trademarks or trademarks of their respective holders.

MODEL AND SUFFIX CODES

DX1000

Model code	Suffix code	Optional code	Description
DX1002			2 ch, 125 ms (Fast sampling mode: 25 ms)
DX1004			4 ch, 125 ms (Fast sampling mode: 25 ms)
DX1006			6 ch, 1 s (Fast sampling mode: 125 ms)
DX1012			12 ch, 1 s (Fast sampling mode: 125 ms)
Internal memory	-1		Standard memory (80 MB)
	-2		Large memory (200 MB)
External media	-4		CF card (with media)
Display language		-2	English/German/French, degF, DST (summer/winter time)
Options	/A1		Alarm output 2 points *1
	/A2		Alarm output 4 points *1
	/A3		Alarm output 6 points *1 *2
	/C2		RS-232 interface *3
	/C3		RS-422A/485 interface *3
	/F1		FAIL/Status output *2
	/H2		Clamped input terminal (detachable)
	/H5		Desktop type (for /P1 model, without power code, screw type power terminal) *4
	/H5[]		Desktop type *5
	/M1		Mathematical functions
	/N1		Cu10,Cu25 RTD input/3 leg isolated RTD
	/N2		3 leg isolated RTD *6
	/N3		Extended input type (PR40-20, Pt50, etc.)
	/P1		24 VDC/AC power supply
	/R1		Remote control
	/TPS2		24 VDC transmitter power supply (2 loops) *7
	/TPS4		24 VDC transmitter power supply (4 loops) *8
	/KB1		Easy text entry (with input terminal) *9 *10
	/KB2		Easy text entry (without input terminal) *9
	/USB1		USB interface
/PM1		Pulse input (including remote control and mathematical functions) *11	
/CC1		Calibration correction function	

*1 /A1, /A2 and /A3 cannot be specified together. *2 /A3 and /F1 cannot be specified together. *3 /C2 and /C3 cannot be specified together. *4 In case that 24 VDC/AC power supply (/P1) and desktop type are specified together, /H5 must be specified. /P1 and /H5[] cannot be specified together.

*5 /H5[]

- D: Power cord UL, CSA st'd
- F: Power cord VDE st'd
- R: Power cord SAA st'd
- J: Power cord BS st'd
- H: Power cord GB st'd

*6 /N2 can be specified for only DX1006 and DX1012. *7 In case that /TPS2 is specified, /TPS4, /A2, /A3 or /F1 cannot be specified together. *8 In case that /TPS4 is specified, /TPS2, /A1, /A2, /A3 or /F1 cannot be specified together. *9 /KB1 and /KB2 cannot be specified together. *10 In case that /KB1 is specified, remote input terminal (438227) is included. *11 In case that /PM1 is specified, /A3, /M1, /R1, /TPS2 or /TPS4 cannot be specified. And combination of /A2/F1 cannot be specified together.

APPLICATION SOFTWARE

Model code	Description	O	S
DXA120	DAQSTANDARD for DXAdvanced		Windows 2000/XP

ACCESSORIES

Product	Model code(part number)	Specification
Shunt resistor (for screw input terminal)	415920	250 Ω ± 0.1 %
	415921	100 Ω ± 0.1 %
	415922	10 Ω ± 0.1 %
Shunt resistor (for clamped input terminal)	438920	250 Ω ± 0.1 %
	438921	100 Ω ± 0.1 %
	438922	10 Ω ± 0.1 %
CF card adapter	772090	—
CF card	772091	128 MB
	772092	256 MB
	772093	512 MB
	772094	1 GB
Mounting bracket	B9900BX	—
Door lock key	B8706FX	—
Remote control terminal	438227	For /KB1, /KB2 option

DX2000

Model code	Suffix code	Optional code	Description
DX2004			4 ch, 125 ms (Fast sampling mode: 25 ms)
DX2008			8 ch, 125 ms (Fast sampling mode: 25 ms)
DX2010			10 ch, 1 s (Fast sampling mode: 125 ms)
DX2020			20 ch, 1 s (Fast sampling mode: 125 ms)
DX2030			30 ch, 1 s (Fast sampling mode: 125 ms)
DX2040			40 ch, 1 s (Fast sampling mode: 125 ms)
DX2048			48 ch, 1 s (Fast sampling mode: 125 ms)
Internal memory	-1		Standard memory (80 MB)
	-2		Large memory (200 MB)
External media	-4		CF card (with media)
Display language		-2	English/German/French, degF, DST (summer/winter time)
Options	/A1		Alarm output 2 points *1
	/A2		Alarm output 4 points *1
	/A3		Alarm output 6 points *1
	/A4		Alarm output 12 points *1
	/A5		Alarm output 24 points *1 *2
	/C2		RS-232 interface *3
	/C3		RS-422A/485 interface *3
	/D5		VGA output
	/F1		FAIL/Status output *2 *4
	/F2		FAIL + Alarm output 22 points *1 *4
	/H2		Clamped input terminal (detachable)
	/H5		Desktop type (for /P1 model, without power code, screw type power terminal) *5
	/H5[]		Desktop type *6
	/M1		Mathematical functions
	/N1		Cu10,Cu25 RTD input/3 leg isolated RTD
	/N2		3 leg isolated RTD *7
	/N3		Extended input type (PR40-20, Pt50, etc.)
	/P1		24 VDC/AC power supply
	/R1		Remote control
	/TPS4		24 VDC transmitter power supply (4 loops) *8
/TPS8		24 VDC transmitter power supply (8 loops) *9	
/KB1		Easy text entry (with input terminal) *10 *11	
/KB2		Easy text entry (without input terminal) *10	
/USB1		USB interface	
/PM1		Pulse input (including remote control and mathematical functions) *12	
/CC1		Calibration correction function	
/MC1		External input function *13	

*1 /A1, /A2, /A3, /A4, /A5, /F2 cannot be specified together. *2 /A5 and /F1 cannot be specified together. *3 /C2 and /C3 cannot be specified together. *4 /F1 and /F2 cannot be specified together. *5 In case that 24 VDC/AC power supply (/P1) and desktop type are specified together, /H5 must be specified. /P1 and /H5[] cannot be specified together.

*6 /H5[]

- D: Power cord UL, CSA st'd
- F: Power cord VDE st'd
- R: Power cord SAA st'd
- J: Power cord BS st'd
- H: Power cord GB st'd

*7 /N2 can be specified for only DX2010, DX2020, DX2030, DX2040 and DX2048. *8 /TPS4, /TPS8, /A5 and /F2 cannot be specified together. *9 In case that /TPS8 is specified, combination of /A4/F1 cannot be specified together. *10 /KB1 and /KB2 cannot be specified together. *11 In case that /KB1 is specified, remote input terminal (438227) is included. *12 In case that /PM1 is specified, /A5, /F2, /M1 and /R1 cannot be specified. And combination of /A2/F1 and combination of /A4/TPS8 cannot be specified together. *13 /MC1 can be specified for only DX2010, DX2020, DX2030, DX2040 and DX2048.

RELATED PRODUCT

DXAdvanced Removable Chassis Model **DX1000N**



Removable Chassis Model featuring easy maintenance.

- This model enables you to pull the inner chassis out from the case without having to remove the power supply, communication, and input wiring on the rear panel

NOTICE

- Before operating the product, read the instruction manual thoroughly for proper and safe operation.
- If this product is for use with a system requiring safeguards that directly involve personnel safety, please contact the Yokogawa sales offices.

A Yokogawa Commitment to Industry

vigilance[®]

quality

innovation

foresight

What does Yokogawa **vigilance** mean to the future of your business? **Quality**. Through products that are built from the ground up and tested to the last hour, you're ensured continuous operation and more uptime. **Innovation**. Your business will benefit from new insights and capabilities, bringing true predictability to your process. **Foresight**. As the market changes, you'll have solutions that give you the continuity and flexibility to plan ahead and grow. Our partners know the difference. With Yokogawa, you can count on a lifetime of plant efficiency, from instrumentation to operation support. Let us be vigilant about your business.

YOKOGAWA ELECTRIC CORPORATION

Network Solutions Business Div./Phone: (81)-422-52-7179, Fax: (81)-422-52-6619

E-mail: ns@cs.jp.yokogawa.com

YOKOGAWA CORPORATION OF AMERICA

Phone: 800-888-6400, Fax: (1)-770-251-6427

YOKOGAWA EUROPE B.V.

Phone: (31)-33-4641806, Fax: (31)-33-4641807

YOKOGAWA ENGINEERING ASIA PTE. LTD.

Phone: (65)-62419933, Fax: (65)-62412606

NetSOL Online

Sign up for our free e-mail newsletter
www.yokogawa.com/ns/

Vig-RS-1E

Printed in Japan, 702(KP) [Ed : 03/b]

Subject to change without notice.

All Rights Reserved, Copyright © 2005, Yokogawa Electric Corporation.

YOKOGAWA